

pco.dicam C1 UHS

intensified 16 bit **sCMOS** camera

1^{channel}
intensified
sCMOS

intensified
sCMOS technology
1504 x 1504 pixel

VUV detection
down to 110 nm

143 fps
@ full resolution

10G fiber optic
data interface



exposure time 2.5 ns
with 18 mm intensifier

double image mode
with 300 ns interframing time

pco.

An Excelitas Technologies Brand



As an expansion of our well established pco.dicam C1 family, we are now adding the pco.dicam C1 UHS models, which are based on 18 mm image intensifiers. Similar to their 25 mm counterparts they are available with a range of high quality 18 mm photo cathodes matching different application requirements. The pco.dicam C1 UHS is the first intensified camera system which exploits the full performance inherent to **scientific CMOS** sensor technology in combination with commonly used 18 mm intensifiers.

It is the optical coupling of 18 mm high resolution image intensifiers with an outstanding high efficiency tandem lens system to a 16 bit 2.3 Mpixel **sCMOS** sensor which makes the camera so unique. The 10G fiber optic based data interface (CLHS FOL) guarantees you uncompressed and robust 16 bit data transfer of 143 full frames per second via optical fiber over virtually any distance.

features & benefits

143 fps @ full 2.3 MPixel resolution	high frame rates at high resolution for imaging of dynamic processes
> 7000 fps @ reduced resolution	kHz scan rates for spectroscopic applications
1.1 e⁻ readout noise	lowest readout noise of any gated intensified camera system
16 bit digitization	taking advantage of the higher dynamic range possible from high-end image intensifiers
optical coupling via ultra-speed tandem lens	outstanding image quality with high transmission efficiency and no artifacts
tandem lens with 0.53 : 1 image scaling	full 18 mm diameter of intensifier output is imaged (lossless) onto an sCMOS sensor
10G fiber optic based data interface	fiber optic interface virtually covers any distance without deploying additional interface converters or signal amplifiers with immunity to EMI
640 MByte/s image data rate	highest sustained image data rate of any intensified camera system on the market; no limitations for recording duration
double image mode with 300 ns interframing time	two consecutive full resolution images with a configurable minimum interframing time of 300 ns
2.3 MPixel sCMOS sensor	overcomes CCD limitations in terms of speed and sensitivity
enhanced extinction ratio gating	fast MCP gating for improved extinction ratio for the blue and uv part of the spectrum
additional optical trigger input	robust trigger transmission over long distance in EMC critical environments
lens remote controller (optional)	convenient remote lens control for camera systems inaccessible during an experiment
selected highly homogeneous image intensifiers	integrated best image intensifier quality available on the market
< 50 ns trigger to exposure start delay	ultra fast camera reaction to trigger event
2.5 ns gating with 18 mm intensifier	captures fast transient phenomena
external modulation of the photocathode sensitivity	multiple exposure with up to 3.3 MHz
VUV detection down to 110 nm with S20 photocathode and MgF₂ input window	sealed camera front mounts to vacuum devices
extensive and highly precise IN/OUT signaling	allows for perfect synchronization in any experimental setup as timing master or slave
configurable delay in steps of 1 ns	flexible adaptation to synchronization needs

camera components overview

- 1 image intensifier
- 2 optical coupling lens system
- 3 sCMOS image sensor
- 4 camera system
- 5 10G fiber optic based interface

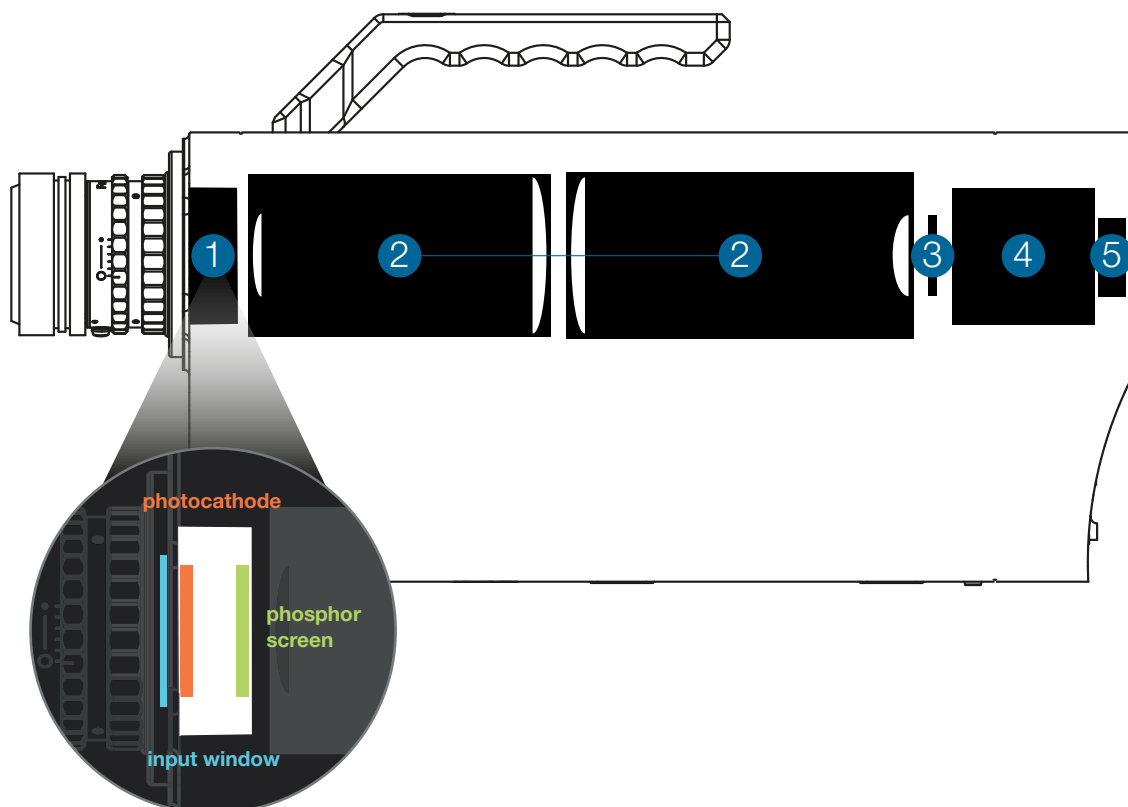

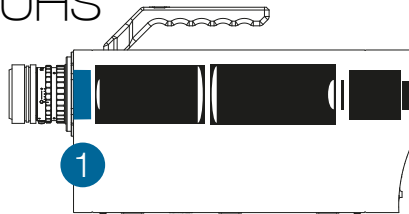

technical specifications

» **image intensifier**

type	HighRes micro channel plate (MCP) 6 µm channel
input window	synthetic silica, borosilicate, MgF ₂
photocathode material	S20, GaAs, GaAsP (others on request)
image intensifier pitch distance	6 µm
image intensifier MCP type	single stage low resistance MCP for high strip current
MCP operational modes	continuous gated for enhanced extinction ratio
image intensifier diameter	18 mm
phosphor screen material	P43, P46
output window	glass
image intensifier system resolution	> 50 lp/mm @ 5 % MTF typical (depends on phosphor)
shortest gating time	2.5 ns

» **image intensifier input window**

Typical transmittance of image intensifier input window materials.

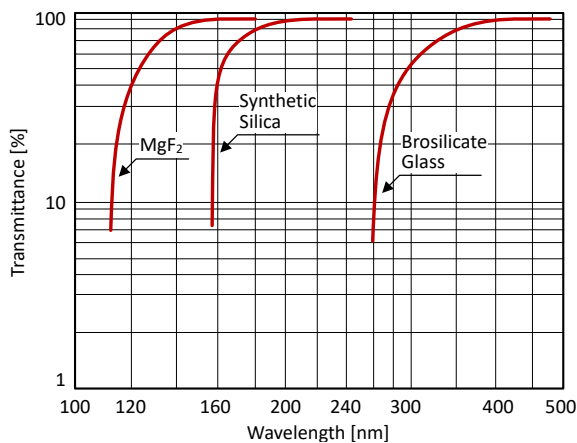

data courtesy of Hamamatsu Photonics

To make use of the good UV sensitivity of S20 photocathode material, the standard input window is made of synthetic silica for transmission down to 180 nm. For VUV detection down to 110 nm, MgF₂ has to be selected as input window.

GaAs and GaAsP photocathodes are deposited on borosilicate glass.

» photocathode quantum efficiency

Spectral sensitivities of different photocathode materials: S20 (multialkali), GaAs, GaAsP

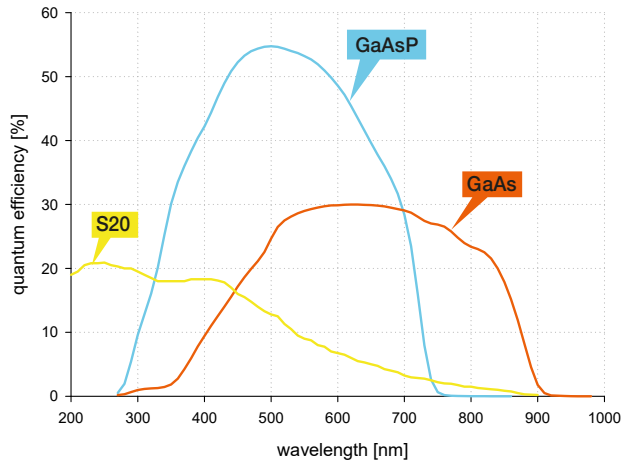

data courtesy of Hamamatsu Photonics

photocathode material	peak wavelength [nm]	typical quantum efficiency at peak wavelength [%]	dark counts [s ⁻¹ /cm ²]
S20 (multialkali)	250	20	1500
GaAs	650	30	30,000
GaAsP	500	55	10,000

data courtesy of Hamamatsu Photonics

» image intensifier phosphor

phosphor	phosphor decay (typ.) to..		peak emission	typical efficiency
	.. 10 %	.. 1 %		
P43	1 ms	4 ms	545 nm	100 %
P46	0.2 - 0.4 μs	2 μs	530 nm	30 %

You can combine all photocathode materials with P43 or P46 phosphor. Whereas the P43 phosphor has a much brighter emission than the P46 phosphor, it has a rather long decay time, i.e. the time required until the phosphor emission fades out after the excitation by electron bombardement has been stopped. This decay time is therefore critical for fast image repetition rates, primarily in double image application or when operating the camera in spectroscopic mode with line rates in the kHz range.

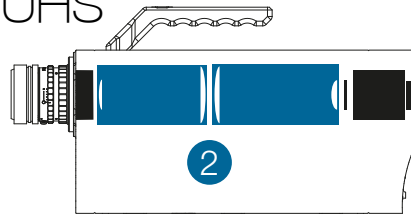

technical specifications

» **optical coupling lens system**

“ultra-speed tandem lens” between image intensifier & sCMOS

transmission efficiency	> 30 %
vignetting	< 3 %
resolution	> 60 lp/mm
scaling rates	$\beta=0.53$ for 18 mm intensifier

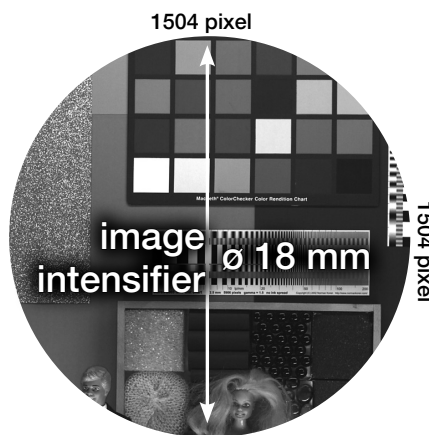

The projected image circle is completely covered by 1504 x 1504 6.5 μm pixels of the sCMOS detector. There is no “waste” of valuable intensifier area. As a consequence, the four corners of the sCMOS sensor remain black. For a fast scan of just a few vertically centered lines – the camera module allows you to achieve more than 7000 fps for such a ROI - the full line length of 1504 pixels is available.

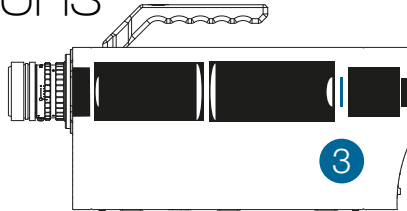

technical specifications

» sCMOS image sensor

type of sensor	scientific CMOS (sCMOS)
resolution (h x v)	1504 x 1504 active pixel
pixel size (h x v)	6.5 μm x 6.5 μm
sensor format / diagonal	9.8 mm x 9.8 mm / 13.8 mm
shutter mode	single image double image
MTF¹	76.9 lp/mm (theoretical)
fullwell capacity	15,000 e ⁻ for P46 phosphor 30,000 e ⁻ for P43 phosphor
readout noise²	1.1 med / 1.5 rms e ⁻ single image 2.2 med / 2.5 rms e ⁻ double image
dynamic range	13,600 : 1 (82.7 dB) for P46 phosphor 27,200 : 1 (88.7 dB) for P43 phosphor
quantum efficiency	58 % for P43 peak emission @ 545 nm 57 % for P46 peak emission @ 530 nm
spectral range	300 nm ... 1000 nm
dark current³	< 0.6 e ⁻ /pixel/s @ 7 °C
DSNU	1.0 rms e ⁻
PRNU	< 0.6 %
anti blooming factor	1 : 10,000

» frame rate table⁴

	C1 UHS	C4 UHS	C8 UHS
1504 x 1504	143 fps	572 fps	1144 fps
1504 x 1024	210 fps	840 fps	1680 fps
1504 x 512	414 fps	1656 fps	3312 fps
1504 x 256	807 fps	3228 fps	6456 fps
1504 x 128	1535 fps	6140 fps	12,280 fps
1504 x 64	2795 fps	11,180 fps	22,360 fps
1504 x 32	4739 fps	18,956 fps	37,912 fps
1504 x 16	7266 fps	29,064 fps	58,128 fps
1280 x 1024	210 fps	840 fps	1680 fps
640 x 480	441 fps	1764 fps	3528 fps
320 x 240	858 fps	3432 fps	6864 fps

¹ Modulation transfer function.

² The readout noise values are given as median (med) and root mean square (rms) values due to the different noise models, which can be used for evaluation. All values are raw data without any filtering.

³ Measurements with dark current compensation.

⁴ Exposure time < 1 μs .

» perfect fit: phosphor emission vs. sCMOS quantum efficiency

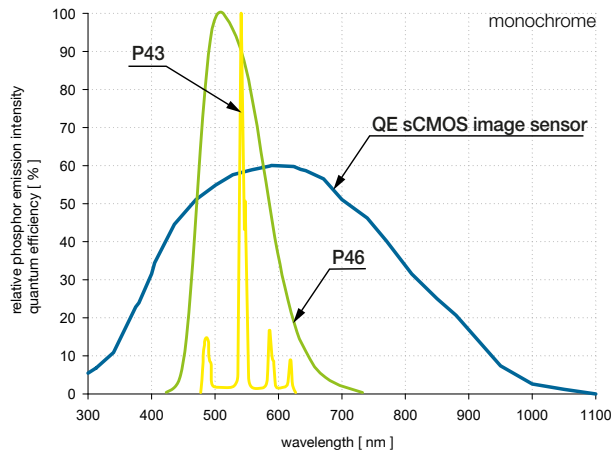

This chart describes the spectral situation for the internal imaging of the image intensifier's phosphor output screen to the sCMOS sensor of the camera detector module. This imaging is done by the highly efficient tandem lens system.

Please note: The spectral sensitivity relevant for your experiment is solely determined by the QE curve of the photocathode material of the image intensifier (page 5).

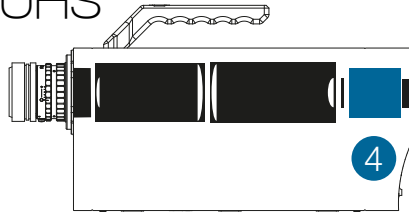

technical specifications

» camera system

frame rate	143 fps @ 1504 x 1504 pixel > 7000 fps @ 1504 x 16 pixel
dynamic range A/D⁵	16 bit
pixel scan rate	286.0 MHz
binning horizontal	x1, x2, x4
binning vertical	x1, x2, x4
region of interest (ROI)	horizontal: steps of 4 pixels vertical: steps of 1 pixel
non-linearity	< 1 %
cooling method	+ 7 °C stabilized, 1 stage peltier with forced air (fan)
input signals	optical trigger (FOL), electrical trigger, arm input (TTL level, BNC connectors), gate disable (high-speed TTL input, BNC connectors)
output signals	gate/expos out monitor, user monitor output (TTL level, BNC connectors)
time stamp	in image (1 µs resolution)

» exposure modes

single image mode

exposure times	fixed values < 20 ns depending on model (e.g. 2.5, 4 , ... , 10 ns), 20 ns ... 250 ns (1 ns steps), 250 ns ... 1 s (10 ns steps)
delay times	0 ns ... 250 ns (1 ns steps), 250 ns ... 1 s (10 ns steps)
maximum repetition... ...with external gating	200 kHz sustained, 3.3 MHz burst
insertion delay	
trigger input to exposure out	19 ns
trigger input to optical open	49 ns
jitter	
trigger input to exposure out	35 ps rms
trigger input to optical open	150 ps rms

double image mode

exposure times	20 ns ... 1 ms (in 10 ns steps)
delay settings	0 ns ... 10 ms (in 10 ns steps)
interframing time	300 ns ... 10 ms (in 10 ns steps)

⁵ The high dynamic signal is simultaneously converted at high and low gain by two 11 bit A/D converters and the two 11 bit values are sophistically merged into one 16 bit value.

» general camera system

power supply	18 ... 28 VDC
power consumption	35 ... 40 W
weight	7 kg
operating temperature	+ 10 °C ... + 40 °C
operating humidity range	10 % ... 80 % (non-condensing)
storage temperature range	- 10 °C ... + 60 °C
optical mount	F-mount optional: C-mount, Canon EF mount
vacuum mount (optional)	sealed camera front attaches to vacuum equipment
lens remote controller (optional)	electronic control for Canon EF lenses
maximum cable length	10 km (CLHS FOL)
CE / FCC certified	yes

pco.dicam C1 UHS

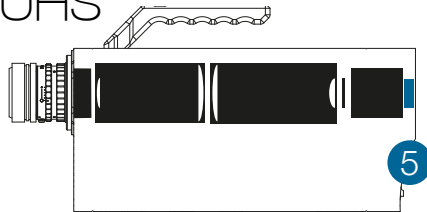

1 channel
intensified
sCMOS

technical specifications

» camera interface

data transfer	Camera Link HS, FOL cable, frame grabber (Single F2, 1X1, S10)
maximum cable length	10 km (CLHS FOL)
input signals	optical trigger (FOL), electrical trigger, arm input (TTL level, BNC connectors), gate disable (high-speed TTL input, BNC connectors)
output signals	gate/expos out monitor, user monitor output (TTL level, BNC connectors)



technical specifications

» lens remote controller

The optional Canon lens control adapter enables you to connect electronic EF and EF-S Canon lenses allowing to remote control focus and aperture of these lenses.



» dimensions

F-mount and C-mount lens changeable adapter. All dimensions are given in millimeter.

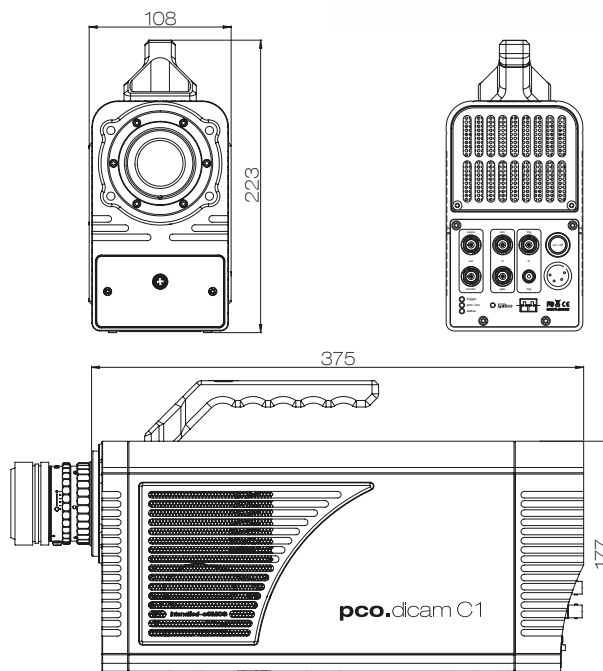

» camera view



» applications

laser induced incandescence (LII) | shock wave physics | laser induced breakdown spectroscopy (LIBS)
particle image velocimetry (PIV) | time resolved spectroscopy | plasmaphysics | laser induced fluorescence (LIF)
ballistics | combustion

» software

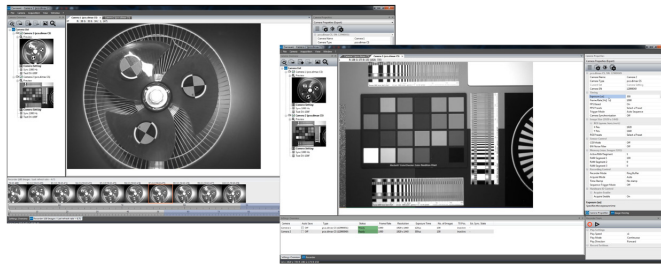

With pco.camware you control all camera settings, the image acquisition, and the storage of your image data. The pco.sdk is the complementary software development kit. It includes dynamic link libraries for user customization and integration on Windows PC platforms. Drivers for popular third party software packages are also available for you.

All these items like pco.camware, pco.sdk, and third party drivers are free to download at www.pco.de

» third party integrations



customization

» possible combinations

photocathode	input window	phosphor
S20 selected	synthetic silica	P46
		P43
GaAs standard	borosilicate	P46
		P43
GaAsP standard	borosilicate	P46
		P43

18 mm image intensifiers are available in two quality grades.

standard	quality specified for central 13.5 mm x 10 mm square region corresponding to 1100 x 810 pixel sCMOS sensor resolution
selected	quality specified for 18 mm diameter area corresponding to full 1504 x 1504 pixel sCMOS sensor resolution, extinction ratio 10 times higher than standard grade, image intensifiers with S20 photocathode exclusively come in selected grade quality. Contact our technical sales team for further details on the two quality grades

» select optical mount

F-mount
C-mount
Canon EF mount

» select interface

type of fiber optic interface (CLHS FOL) module in camera and frame grabber

SM SFP+ up to 10 km
MM SFP+ up to 300 m
FOL cable length default: 10 m

contact

pco europe

+49 9441 2005 50
info@pco.de
pco.de

pco america

+1 866 678 4566
info@pco-tech.com
pco-tech.com

pco asia

+65 6549 7054
info@pco-imaging.com
pco-imaging.com

pco china

+86 512 67634643
info@pco.cn
pco.cn



for application stories
please visit our website

pco.

An Excelitas Technologies Brand